

Temposonics®

Magnetostrictive, Absolute, Non-contact
Linear-Position Sensors



E-Series Model EH CANopen Output Data Sheet

Document Part Number:
551313 Revision B



Model EH rod-style position sensor
Stroke Length: 50 mm to 2500 mm (or 2 in. to 100 in.)

FEATURES

- Linear, Absolute Measurement
- Non-Contact Sensing Technology
- Linearity Deviation Less Than 0.02% F.S.
- Repeatability Within 0.005% F.S.
- CANopen Interface:
 - Direct Position Output
 - Velocity Output
- Single or Dual Magnet Measurements
- Stroke Length Range: 50 mm to 2500 mm (or 2 in. to 100 in.)
- Hermetically-Sealed Stainless Steel For IP69K Ingress Protection
- EMI Shielded and CE Certified

BENEFITS

- Compact Stainless Steel Position Sensor, Designed For Use In Hydraulic Cylinders
 - Standard 10 mm dia. Sensor Rod For Typical Applications
 - Optional 7 mm dia. Sensor Rod For Use In Small Bore Cylinders
- Simultaneous Multi-position Measurements for 2 Magnets
- Over Voltage Protection to 36 Vdc and Polarity Protection up to -30 Vdc

APPLICATIONS

- Clevis Mounted or Space Limited Cylinder Applications
- Harsh Industrial Conditions
- High-Pressure Washdown
- Gates and Valve Control

TYPICAL INDUSTRIES

- Fluid Power
- Factory Automation
- Steel Mills
- Material Handling and Packaging
- Water Management

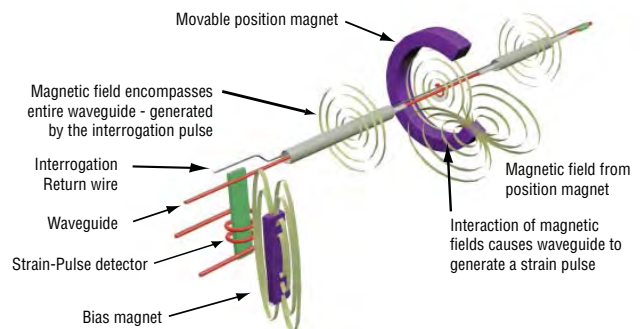

Benefits of Magnetostriction

Temposonics linear-position sensors use the time-based magnetostrictive position sensing principle developed by MTS. Within the sensing element, a sonic-strain pulse is induced in a specially designed magnetostrictive waveguide by the momentary interaction of two magnetic fields. One field comes from a movable permanent magnet that passes along the outside of the sensor. The other field comes from an "interrogation" current pulse applied along the waveguide. The resulting strain pulse travels at sonic speed along the waveguide and is detected at the head of the sensing element.

The position of the magnet is determined with high precision and speed by accurately measuring the elapsed time between the application of the interrogation pulse and the arrival of the resulting strain pulse with a high-speed counter. The elapsed time measurement is directly proportional to the position of the permanent magnet and is an absolute value. Therefore, the sensor's output signal corresponds to absolute position, instead of incremental, and never requires recalibration or re-homing after a power loss. Absolute, non-contact sensing eliminates wear, and guarantees the best durability and output repeatability.

Sold & Serviced By:



Toll Free Phone (877) SERV098
Toll Free Fax (877) SERV099
www.electromate.com
sales@electromate.com

E-Series Model EH Sensor, CANopen Output Product Overview/Specifications

Product overview

MTS Sensors continues to establish new performance standards for low-cost, fully-industrial, durable position sensors using the widely preferred magnetostrictive technology. This principle for accurate and non-contact measurement of linear-position sensing was developed 30 years ago by MTS and is used with outstanding success in a large variety of industrial applications. The Temposonics model EH sensor provides as much performance as you need for your application - you benefit from the advantages of magnetostrictive position measurement at optimum costs.

The Temposonics® Model EH sensor features a pressure resistant sensor rod for direct stroke measurement inside hydraulic cylinders. With its minimized sensor head and either a 7 mm or 10 mm rod, it is the ideal solution when space is critical. For long strokes, the model EH is available with measuring ranges up to 2500 mm (or 100 in.).

The model EH sensor offers completely sealed stainless-steel housing for long life position measurement for rugged environments. When installed with the appropriate mating connector and cable, it features protection up to IP69K and is suitable for high-pressure washdown applications.

Product specifications

Parameters	Specifications
OUTPUT	
Measured output variables:	Position, Velocity for single or dual magnets
Resolution:	Position: 10 µm, 20 µm Velocity: 1mm/s
Update times:	1.0 ms up to 2400 mm
Linearity deviation:	< ± 0.02% full stroke (minimum ± 60 µm)
Repeatability:	< ± 0.005% full stroke (minimum ± 10 µm)
Outputs:	Interface: CAN-Fieldbus System according to ISO-DIS 11898 Data protocol: CANopen Encoder Profile DS 406 V3.1 CiA Standard DS 301 v3.0
Baud rate, kBit/s:	1000 800 500 250 125
Cable length, m:	< 25 < 50 < 100 < 250 < 500
Stroke length:	Range: 50 mm to 2500 mm (or 2 in. to 100 in.)

ELECTRONICS

Operating voltage:	+24 Vdc nominal: -15% or +20% Polarity protection: ≥ -30 Vdc Over voltage protection: ≤ 36 Vdc Current drain: 40 to 60 mA <i>(Stroke length dependent)</i> Dielectric withstand voltage: 500 Vdc (DC ground to machine ground)
---------------------------	---

Parameters	Specifications
ENVIRONMENTAL	
Operating conditions:	Operating temperature: -40 °C (-40 °F) to 75 °C (167 °F) Relative humidity: 90% no condensation Ingress protection: IP69K <i>(when appropriate mating connector is correctly fitted)</i>
EMC test:	Electromagnetic emission: EN 61000-6-4 (for use in industrial environment) Electromagnetic immunity: EN 61000-6-2. The sensor meets the requirements of the EC directives and is marked with CE.
Shock rating:	100 g (single hit)/ IEC standard EN 60068-2-27
Vibration rating:	15 g/10 to 2000 Hz, IEC standard EN 60068-2-6 (resonance frequencies causing excess of 15 g are excluded)
WIRING	
Connection type:	5-pin (M12) male integral connector

ROD-STYLE SENSOR (MODEL EH)

Electronic head:	Stainless steel 1.4301 / AISI 304
Sensor rod:	Stainless steel 1.4301 / AISI 304
Operating pressure:	7 mm Rod: 300 bar static, 350 bar peak (4350 psi static , 5076 psi peak) 10 mm rod: 350 bar static, 450 bar peak (5076 psi static , 6526 psi peak)

Typical mounting torque:	45 N-m (33 ft. - lbs.)
Magnet types:	Ring magnet, open-ring magnet or magnet float

Sold & Serviced By:



Toll Free Phone (877) SERV098
Toll Free Fax (877) SERV099
www.electromate.com
sales@electromate.com

CANopen communication and functionality

Temposonics linear-position sensors fulfill all requirements of CANbus (ISO 11898). The sensor's electronics convert the position measurements into bus oriented outputs and transfer this data directly to the controller. The CANbus interface is appropriate for serial data transfer up to 1 Mbps maximum. Sensor integrated software supports bus profile CANopen. This communication protocol allows for a comprehensive customized configuration of the sensor-bus system.

TEMPOSONICS E-SERIES SENSORS WITH CANopen INTERFACE

E-Series sensors with CANopen protocol are based as bus-nodes on the OSI reference model and are available with application data for single or dual-magnet measurements:

Application data:

- Position measurement
- Velocity measurement
- Setpoints
- Status

CANopen corresponds to encoder profile 'DS-406 V3.1 (CiA Draft standard DS-301 V3.0)'. The CANopen functionality is described below in the following communication objects.

CANopen CONFIGURATION TOOL

The EDS (Electronic Data Sheet) download is available at www.mtssensors.com for configuration.

SERVICE DATA OBJECT (SDO)

The SDO is mainly used for sensor configuration. SDO messages are used for read and write access to all entries in the object directory.

Selectable parameters are as follows:

- Operational range setup for magnets 1 and 2
- Zero adjustmet preset for magnets 1 and 2
- 4 set points for each magnet

PROCESS DATA OBJECT (PDO)

The PDO provides data transfer of sensor measurements in up to 8-byte data blocks. The sensor uses PDO's to relay parameters for each magnet in one or two PDO's

Data formats:

- Position
- Velocity
- Limit status
- Limit status of operational range

PDO TRANSMISSION TYPES

- Asynchronous (cycle time of 1 to 65.535 ms) or synchronous
- Synchronization Object (SYNC) messages are sent from the controller to the sensor, the sensor then transmits measurement values

SYNC OBJECT

Is responsible for synchronized bus communication

EMERGENCY OBJECT

Emergency messages are transmitted as:

- Sensor signal breakdown
- Communication fault

E-Series Model EH Sensor, CANopen Output Measurement Options and Dimension References

Dual magnet outputs

MEASUREMENT OPTIONS

E-Series sensors provide options for simultaneous multi-position measurements by using up to two magnets per sensor.

The options for single-magnet or dual-magnets is specified in the sensor model number when ordered. For single-magnet sensors the sensor's full active stroke length is utilized by the one magnet. For example when using forward-acting outputs, the output is 0% of its value when the magnet is at the null position (start of stroke) and 100% of its value when at the edge of the dead zone (end of stroke), (see 'Figure 1').

However, for dual-magnet sensors the sensor's active stroke length must be shared by the two magnets, and a separation \geq or $=$ 75 mm (3 in.) must be maintained between the two magnets (front side of the first magnet to front side of the second magnet). This minimum distance between magnets is needed to maintain proper sensor output. Therefore, for the second magnet the start of stroke (0% output) is set at 75 mm away from the sensor's null position. Likewise, for the first magnet the end of stroke (100% output) is now set 75 mm away from the edge of the dead zone (see 'Figure 1').

The result of using the dual-magnet E-Series options is that the stroke length available for each magnet is 75 mm less (or 3 inches less when specifying stroke length in inches) than the sensor's full active stroke length as indicated in the model number.

When ordering the single-magnet E-Series sensor the minimum stroke length available is 50 mm or 2 inches. However when ordering dual magnet E-Series sensors the minimum stroke length available is 125 mm (i.e. 50 mm minimum, plus 75 mm for the minimum distance between magnets). Likewise, when specifying stroke length in inches the minimum stroke length available is 5 inches (i.e. 2 inch minimum, plus 3 inches for the minimum distance between magnets).

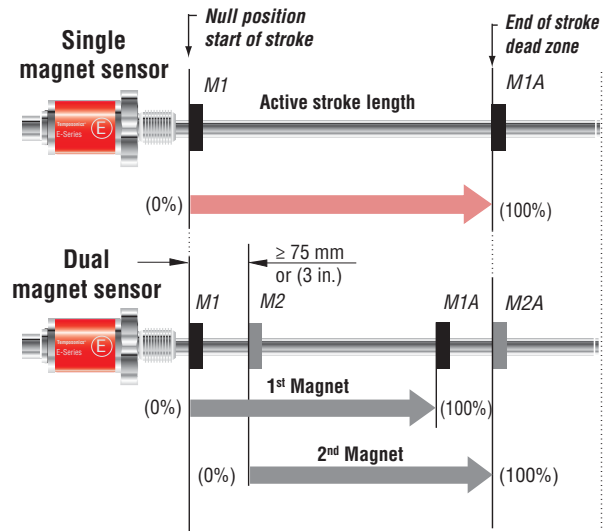

Figure 1. Single and dual-magnet measurements

Sensor dimension references

Drawings are for reference only, contact applications engineering for tolerance specific information.

The model EH sensor shown in 'Figure 2' can be ordered with flange styles M18 x1.5 or 3/4 -16 UNF-3A and a 7 mm or 10 mm diameter sensor rod. Magnets must be purchased separately; refer to 'Standard magnet Selections (Model EH)' for standard magnet ordering information.

MODEL EH

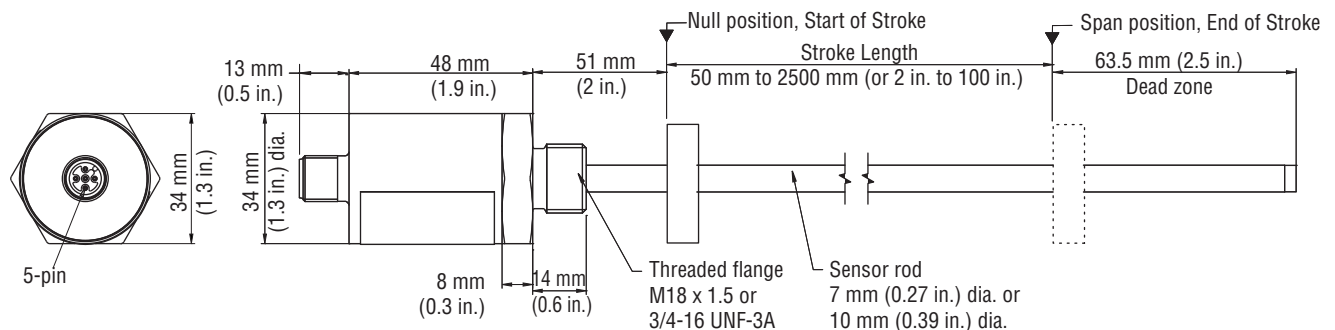

Refer to the model EH sensor ordering information for rod housing and flange types

Figure 2. E-Series model EH sensor dimension reference

Sold & Serviced By:

ELECTROMATE

Toll Free Phone (877) SERV098

Toll Free Fax (877) SERV099



www.electromate.com

sales@electromate.com

Standard magnet options (Model EH)

Magnets must be ordered separately with Model RH position sensors. The standard ring magnet (part number 201542-2) is suitable for most applications.

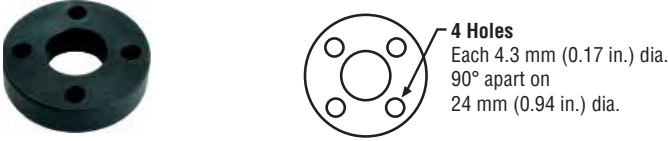
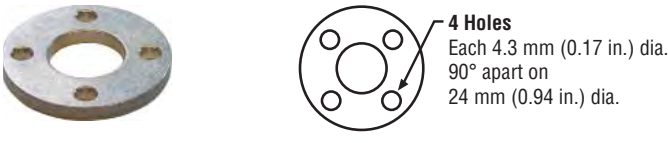
POSITION MAGNET SELECTIONS (Magnet must be ordered separately) *(Drawing dimensions are for reference only)*

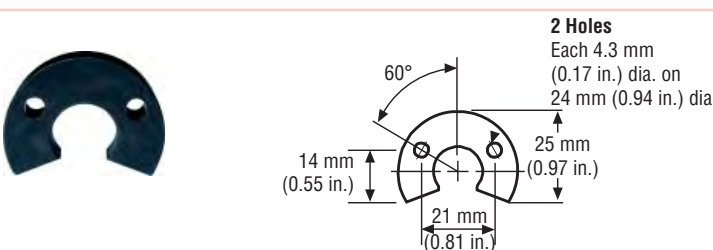
Magnet and magnet dimensions	Description	Part number
 <p>4 Holes Each 4.3 mm (0.17 in.) dia. 90° apart on 24 mm (0.94 in.) dia.</p>	<p>Standard ring magnet I.D.: 13.5 mm (0.53 in.) O.D.: 33 mm (1.3 in.) Thickness: 8 mm (0.3 in.) Operating temperature: - 40 °C to 100 °C</p>	201542-2
 <p>4 Holes Each 4.3 mm (0.17 in.) dia. 90° apart on 24 mm (0.94 in.) dia.</p>	<p>Magnet spacer (Non-ferrous, use with ring magnet Part number: 201542-2) I.D.: 14 mm (0.56 in.) O.D.: 32 mm (1.25 in.) Thickness: 3.2 mm (0.125 in.)</p>	400633
	<p>Ring magnet I.D.: 13.5 mm (0.53 in.) O.D.: 25.4 mm (1 in.) Thickness: 8 mm (0.3 in.) Operating temperature: - 40 °C to 100 °C</p>	400533
 <p>2 Holes Each 4.3 mm (0.17 in.) dia. on 24 mm (0.94 in.) dia. 60° 14 mm (0.55 in.) 25 mm (0.97 in.) 21 mm (0.81 in.)</p>	<p>Open-ring magnet, Style M I.D.: 13.5 mm (0.53 in.) O.D.: 33 mm (1.3 in.) Thickness: 8 mm (0.3 in.) Operating temperature: - 40 °C to 100 °C</p> <p>This magnet may influence the sensor performance specifications for some applications.</p>	251416-2

MAGNET FLOAT SELECTION *(Drawing dimensions are for reference only)*

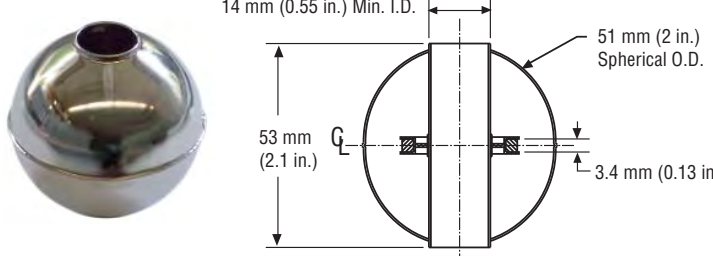
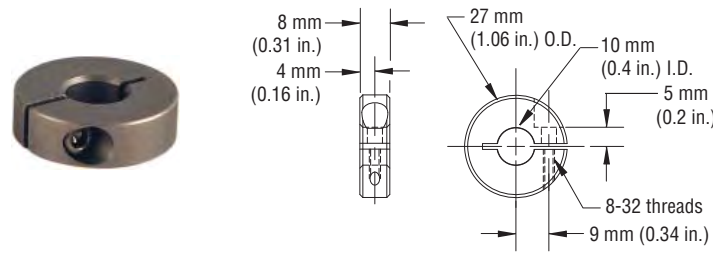
 <p>14 mm (0.55 in.) Min. I.D. 53 mm (2.1 in.) 51 mm (2 in.) Spherical O.D. 3.4 mm (0.13 in.)</p>	<p>Magnet float (Level sensing applications) Specific gravity: 0.70 maximum Pressure: 870 psi maximum</p> <p>(This float is used with Model RH rod-style sensors for hydraulic fluid or fresh water applications only). Collar (part no.: 560777) is recommended for end of stroke stops.</p>	251447
 <p>8 mm (0.31 in.) 4 mm (0.16 in.) 27 mm (1.06 in.) O.D. 10 mm (0.4 in.) I.D. 5 mm (0.2 in.) 8-32 threads 9 mm (0.34 in.)</p>	<p>Collar Provides end of stroke stops for magnet float (part no.: 251447)</p>	560777

E-Series Model EH Sensor, CANopen Output Sensor Mounting, Connections and Wiring

Model EH Rod-Style sensor mounting

MODEL EH SENSOR MOUNTING

The model EH sensor is designed for direct stroke measurement inside prepared hydraulic cylinders. At the head of the sensor, a threaded flange and O-Ring provides for mounting and sealing the sensor into a port opening in the cylinder end cap. The sensor's pressure resistant rod fits into a bore drilled through the center of the piston head and rod assembly. The sensor's position magnet is mounted on the top of the piston head or installed in a shallow counter-bore inside the piston head.

The position magnet requires minimum distances away from ferrous metals to allow proper sensor output. The minimum distance from the front of the magnet to the cylinder end cap is 15 mm (0.6 in.).

The minimum distance from the back of the magnet to the piston head is 3.2 mm (0.125 in.). However, a minimum distance of at least 5 mm (0.197 in.) is preferred for performance margin. The non-ferrous spacer (part no. 400633), provides this minimum distance when used along with the standard ring magnet (part no. 201542-2), as shown in 'Figure 3'.

The magnet is usually secured using non-ferrous fastening material (customer supplied). Screws must be made of nonmagnetic stainless steel or brass. In the event that a ferrous circlip or retaining ring will be used to secure the magnet in a counter-bore then an additional non-ferrous spacer (> or = 3.2 mm) must be placed between the circlip or retaining ring and the front side of the magnet.

The cylinder's design ratings for hydraulic pressure and piston velocity will determine the appropriate size for the bore that is drilled through the center of the piston head and rod assembly. The recommended minimum size for this bore is 10 mm (0.39 in.) when using the 7 mm (0.27 in.) diameter sensor rod.

Likewise, the recommended minimum size of 13 mm (0.51 in.) should be used when installing the 10 mm diameter sensor rod. Some applications using long sensor rods may benefit by adding a bushing (e.g. made of flourelastomer material) to prevent wear on the magnet and sensor rod (customer supplied).

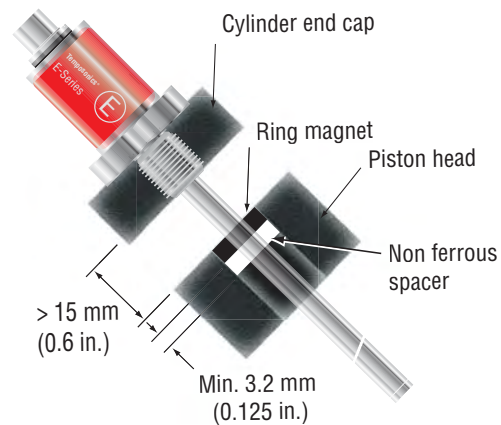

Figure 3. Model EH rod-style mounting

Connections and wiring (Model EH)

SENSOR INTEGRAL CONNECTOR (D34) PINOUT/WIRE COLOR CODES

The E-Series Model EH sensor connects directly to a controller or interface module with the standard male, 5-pin integral connector and an extension cable as described in 'Table 1'



Integral D34 connector (male) as viewed from the end of the sensor

Pin no.	Signal/function CANopen outputs
1	Shield
2	+24 Vdc
3	DC ground (for power return)
4	CAN (+)
5	CAN (-)

Table 1. Integral D34 sensor connector

Sold & Serviced By:

 **ELECTROMATE**

Toll Free Phone (877) SERV098

Toll Free Fax (877) SERV099

www.electromate.com

sales@electromate.com

**E-Series Model EH Sensor, CANopen Output
Cable Connector Options (D34)**

FIELD INSTALLABLE CABLE CONNECTOR OPTIONS FOR 5-PIN (D34) CONNECTOR TYPES

(Photo and drawing dimensions are for reference only)

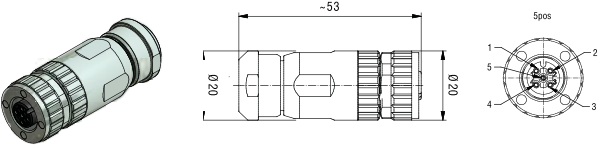
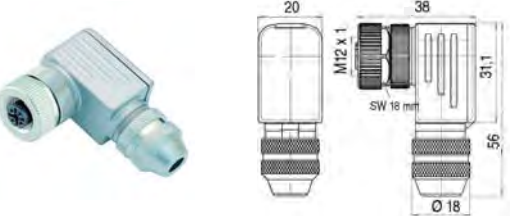
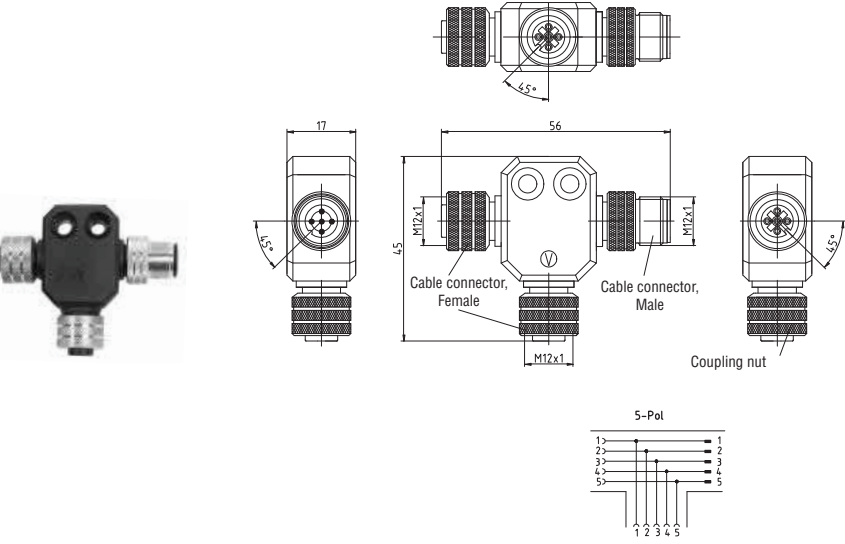
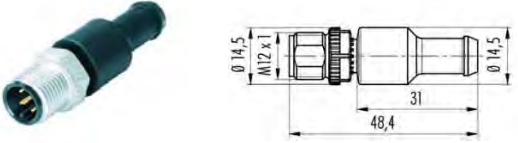
Connector and dimensions	Description	Part number
	<p>Female cable connector, straight exit (Field installable) 5-Pin (D34) connector Termination: Screw terminals Cable gland: For 4 to 8 mm dia. cable</p>	370677
	<p>Female cable connector, 90° exit (Field installable) 5-Pin (D34) connector. Termination: Screw terminals Cable gland: For 6 to 8 mm dia. cable</p>	370678
	<p>T connector, shielded 5-Pin M12 connector IP 67</p>	370691
	<p>Male CANbus termination connector, straight exit 5-Pin M12 connector.</p>	370700

Sold & Serviced By:



Toll Free Phone (877) SERV098

Toll Free Fax (877) SERV099

www.electromate.com

sales@electromate.com

E-Series Model EH Sensor, CANopen Output

Ordering Information

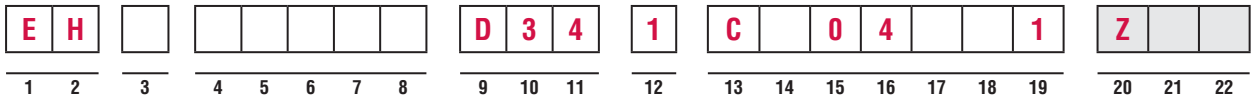

(Use the order matrix above to configure your Model EH sensor order number)

SENSOR MODEL _____ = **E H** 1 - 2
EH = E-Series model EH rod-style sensor (Magnet(s) must be ordered separately)

HOUSING STYLE _____ = _____ 3
K = Flange M18 x 1.5 / Rod 7 mm dia.
M = Flange M18 x 1.5 / Rod 10 mm dia.
L = Flange 3/4 in. UNF / Rod 7 mm dia.
S = Flange 3/4 in. UNF / Rod 10 mm dia.

STROKE LENGTH _____ = _____ 4 - 8
 _____ **M** = Millimeters (Encode in 5, 10, 25 or 50 mm increments) as indicated in 'Stroke length notes' below.
 _____ **U** = Inches (Encode in 0.2, 0.5, 1 or 2 in. increments) as indicated in 'Stroke length notes' below.

Stroke Length Notes:

Stroke length ranges:
M = 50 mm to 2500 mm
U = 2 in. to 100 in.

The increment size between standard stroke lengths vary as shown below:

Stroke length (mm)	Ordering increment
≤ 500 mm	5 mm
> 500 mm and ≤ 750 mm	10 mm
> 750 mm and ≤ 1000 mm	25 mm
> 1000 mm and ≤ 2500 mm	50 mm
Stroke length (IN)	Ordering increment
≤ 20 in.	0.2 in.
> 20 mm and ≤ 30 mm	0.5 in.
> 30 mm and ≤ 40 mm	1 in.
> 40 in. and ≤ 100 in.	2 in.

SENSOR CONNECTION TYPES _____ = **D 3 4** 9 - 11
D34 = 5-Pin (M12), male, (CANopen output)

INPUT VOLTAGE _____ = **1** 12
1 = +24 Vdc (+20%, -15%), standard

OUTPUT _____ = **C 0 4 1** 13-19
C _____ = CANopen output - Enter the 6-digit output code (1-6) defined by the selections below:
 [1] [2] [3] [4] [5] [6]

[1] [2] [3] Protocol	[4] Baud rate	[5] Resolution	[6] type
304 = CANopen 1 or 2 magnets	1 = 1000 kBit/s 2 = 500 kBit/s	4 = 10 μm 5 = 20 μm	1 = Standard
404 = CANopen 1 or 2 magnets with integrated bus terminator resistor (120 Ohms)	3 = 250 kBit/s 4 = 125 kBit/s		

NUMBER OF MAGNETS (20-22) FOR MULTI-POSITION MEASUREMENT ONLY _____ = **Z** 20-22
Z + Enter a 2-digit code
Z _ _ = Enter 02 for 2 magnets